



BRAZO NEUMÁTICO/PISTÓN ELEVADOR

Material	Acero galvanizado - plástico	
Acabado superficial	Pintura electroestática plateada	
Capacidad de carga	80 Newton (puertas de 3 a 4 kg)	
Montaje	Para atornillar	
Durabilidad	100.000 ciclos de apertura y cierre	
Resistencia a la corrosión	Fabricado en acero Cold Rolled con acabado de pintura electroestática	
Empaque incluye	 POR BOLSA	1 set de pistón y enganches 5 tornillos
	 POR CAJA	100 bolsas 

- RESISTENTE A LA CORROSIÓN
- INCLUYE TORNILLOS
- 100.000 CICLOS DE USO
- ABERTURA LIBRE
- CALIDAD GARANTIZADA



Diagrama de piezas del producto

BRAZO NEUMÁTICO/
PISTÓN ELEVADOR

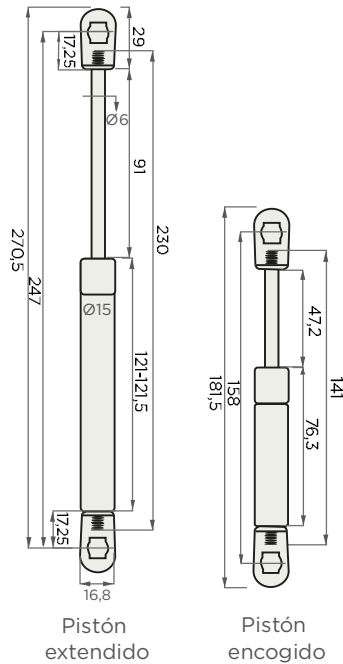

ENGANCHE
LATERAL

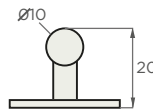
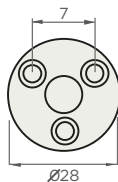

ENGANCHE
PUERTA

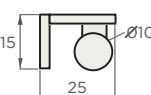

Diagrama de instalación

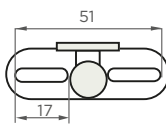